

Photo Reflective Sensor

Module No.: RS-05FS

1. General Description

RS-05FS reflective sensor combines a GaAs infrared light emitting diode with a high sensitive phototransistor in a super mini chip-type package, reducing installation space.

2. Features

- Compact
- High performance
- High speed response
- Easy to mount on P.C.B.
- Widely applicable

3. Applications

- ▣ Timing sensors
- ▣ Edge sensors
- ▣ Micro floppy disc drives
- ▣ Level sensors of liquid

4. Maximum Ratings

(Ta=25°C)

	Item	Symbol	Rating	Unit
Input	Power Dissipation	P_D	75	mW
	Reverse Voltage	V_R	5	V
	Forward Current	I_F	50	mA
	Pulse Forward Current *1	I_{FP}	1	A
Output	Collector Power Dissipation	P_c	50	mW
	Collector Current	I_c	20	mA
	C-E Voltage	V_{CEO}	30	V
	E-C Voltage	V_{ECO}	3	V
Operating Temperature		T_{opr}	-25 ~ +85	°C
Storage Temperature		T_{stg}	-30 ~ +95	°C
Soldering Temperature *2		T_{sol}	240	°C

*1. $t_w=100\mu\text{sec}$. $T=10\text{msec}$.

*2. At the position of 2mm from the bottom of the package within 5 seconds.

5. Electro-optical Characteristics

(Ta=25°C)

	Item	Symbol	Conditions	Min.	Typ.	Max.	Unit
Input	Forward Voltage	V_F	$I_F=10\text{mA}$			1.3	V
	Reverse Current	I_R	$V_R=5\text{V}$			10	μA
	Capacitance	C_t	$V=0\text{V}$, $f=1\text{kHz}$		25		pF
	Peak Wavelength	λ_p			940		nm
Output	Collector Dark Current	I_{CEO}	$V_{CE}=10\text{V}$			0.2	μA
	Light Current	I_L	$V_{CE}=5\text{V}$, $I_F=10\text{mA}$	90			μA
	Leakage Current	$I_{CEO D}$	$V_{CE}=5\text{V}$, $I_F=10\text{mA}$			0.2	μA
Switching Speeds	Rise Time	t_r	$V_{CC}=2\text{V}$, $I_c=100\mu\text{A}$,		30		μsec
	Fall Time	t_f	$R_L=1\text{k}\Omega$		25		μsec

Dimensions (Unit: mm)

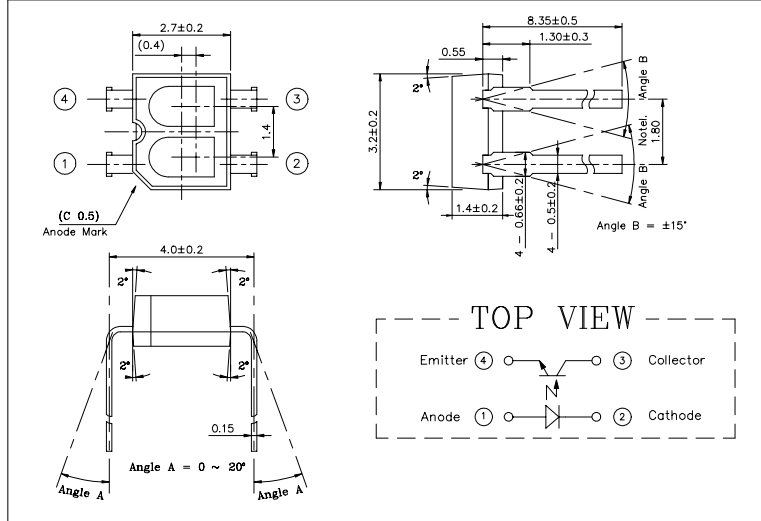
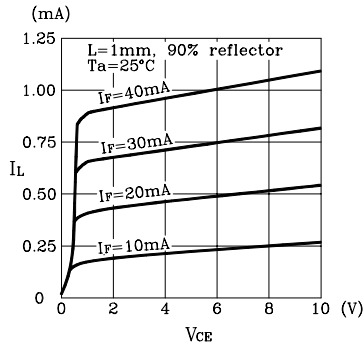

Photo Reflective Sensor

Module No.: RS-05FS

Light Current vs Collector-Emitter Voltage



Forward Current vs Forward Voltage

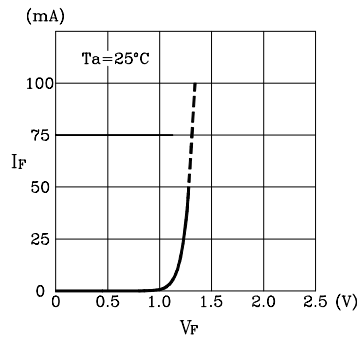

Power Dissipation vs Ambient Temperature

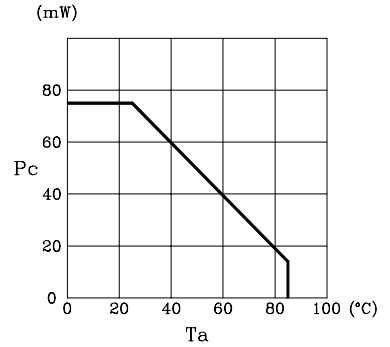

Dark Current vs Ambient Temperature

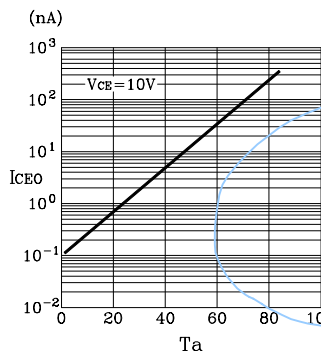

Light Current vs Forward Current

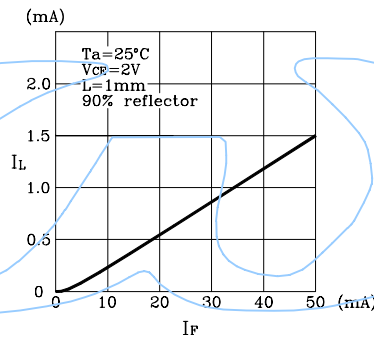

Relative Light Current vs Ambient Temperature

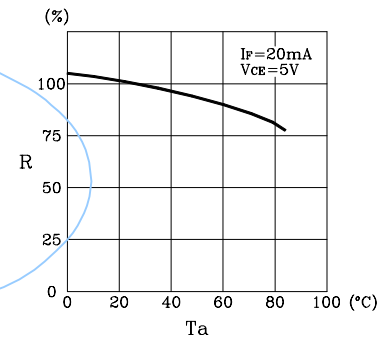

Response Time vs Load Resistance

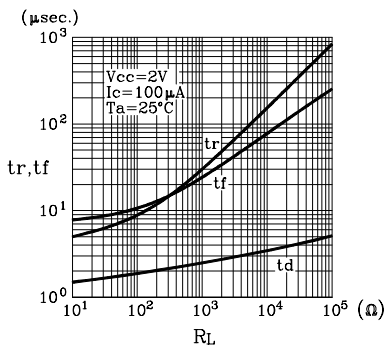

Position Detect Characteristics

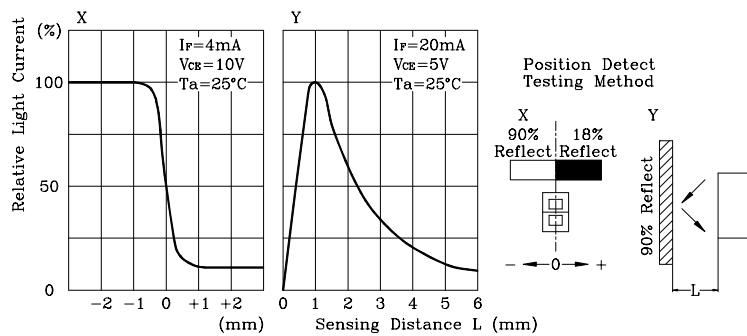

Response Time Test Conditions

